

### FEATURES

**Complete 12-Bit D/A Function**  
**On-Chip Output Amplifier**  
**High Stability Buried Zener Reference**  
**Fast 40 ns Write Pulse**  
**0.3" Skinny DIP and PLCC Packages**  
**Single Chip Construction**  
**Monotonicity Guaranteed Over Temperature**  
**Settling Time: 3  $\mu$ s max to 1/2 LSB**  
**Guaranteed for Operation with  $\pm 12$  V or  $\pm 15$  V Supplies**  
**TTL/5 V CMOS Compatible Logic Inputs**  
**MIL-STD-883 Compliant Versions Available**

### FUNCTIONAL BLOCK DIAGRAM

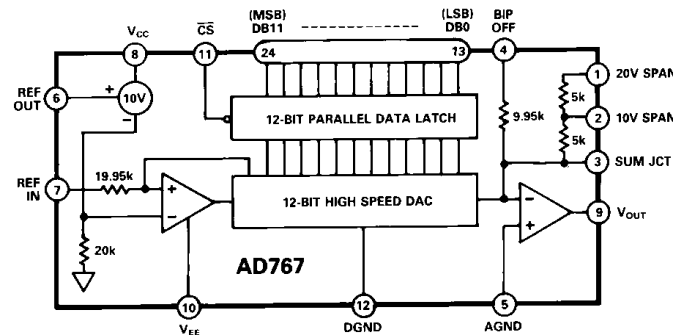

### PRODUCT DESCRIPTION

The AD767 is a complete voltage output 12-bit digital-to-analog converter including a high stability buried Zener reference and input latch on a single chip. The converter uses 12 precision high-speed bipolar current steering switches and a laser-trimmed thin-film resistor network to provide high accuracy.

Microprocessor compatibility is achieved by the on-chip latch. The design of the input latch allows direct interface to 12-bit buses. The latch responds to strobe pulses as short as 40 ns, allowing use with the fastest available microprocessors.

The functional completeness and high performance of the AD767 result from a combination of advanced switch design, high-speed bipolar manufacturing process, and the proven laser wafer-trimming (LWT) technology.

The subsurface (buried) Zener diode on the chip provides a low-noise voltage reference which has long-term stability and temperature drift characteristics comparable to the best discrete reference diodes. The laser trimming process which provides the excellent linearity is also used to trim the absolute value of the reference as well as its temperature coefficient. The AD767 is thus well suited for wide temperature range performance with  $\pm 1/2$  LSB maximum linearity error and guaranteed monotonicity over the full temperature range. Typical full-scale gain T.C. is 5 ppm/ $^{\circ}$ C.

### PRODUCT HIGHLIGHTS

1. The AD767 is a complete voltage output DAC with voltage reference and digital latches on a single IC chip.
2. The input latch responds to write pulse widths as short as 40 ns assuring direct interface with the industry's fastest microprocessors.
3. The internal buried Zener reference is laser-trimmed to 10.00 volts with a  $\pm 1\%$  maximum error. The reference voltage is also available for external application.
4. The gain setting and bipolar offset resistors are matched to the internal ladder network to guarantee a low gain temperature coefficient and are laser trimmed for minimum full-scale and bipolar offset errors.
5. The precision high-speed current steering switches and on-board high-speed output amplifier settle within 1/2 LSB for a 10 V full-scale transition in 3.0  $\mu$ s when properly compensated.
6. The AD767 is available in versions compliant with MIL-STD-883. Refer to the Analog Devices Military Products Databook or current AD767/883B data sheet for detailed specifications.

\*Protected by Patent Numbers 3,803,590; 3,890,611; 3,932,863; 3,978,473; 4,020,486; and others pending.

### REV. A

Information furnished by Analog Devices is believed to be accurate and reliable. However, no responsibility is assumed by Analog Devices for its use, nor for any infringements of patents or other rights of third parties which may result from its use. No license is granted by implication or otherwise under any patent or patent rights of Analog Devices.

**One Technology Way, P.O. Box 9106, Norwood, MA 02062-9106, U.S.A.**  
**Tel: 617/329-4700** **Fax: 617/326-8703**

# AD767—SPECIFICATIONS (T<sub>A</sub> = +25°C, ±15 volt power supplies, Unipolar Mode, unless otherwise noted.)

Model	AD767J/A/S <sup>1</sup>			AD767K/B			AD767A <sup>2</sup> Chips			Units
	Min	Typ	Max	Min	Typ	Max	Min	Typ	Max	
<b>DIGITAL INPUTS</b>										
Resolution			12			12			12	Bits
Logic Levels (TTL Compatible, T <sub>MIN</sub> -T <sub>MAX</sub> ) <sup>3</sup>										
V <sub>IH</sub> (Logic "1")	<b>+2.0</b>		<b>+5.5</b>	<b>+2.0</b>		<b>+5.5</b>	<b>+2.0</b>		<b>+5.5</b>	V
V <sub>IL</sub> (Logic "0") J, K, A, B	0		<b>+0.8</b>	0		<b>+0.8</b>	0		<b>+0.8</b>	V
V <sub>IL</sub> (Logic "0") S	0		<b>+0.7</b>							V
I <sub>IH</sub> (V <sub>IH</sub> = 5.5 V)		3	<b>10</b>		3	<b>10</b>		3	<b>10</b>	μA
I <sub>IL</sub> (V <sub>IL</sub> = 0.8 V)		1	5		1	5		1	5	μA
<b>TRANSFER CHARACTERISTICS</b>										
<b>ACCURACY</b>										
Linearity Error @ +25°C		±1/2	<b>±1</b>		±1/8	<b>±1/2</b>		±1/2	<b>±1</b>	LSB
T <sub>A</sub> = T <sub>MIN</sub> to T <sub>MAX</sub>		±1/2	<b>±1</b>		±1/4	<b>±1/2</b>		±1/2	<b>±1</b>	LSB
Differential Linearity Error @ +25°C		±1/2	<b>±1</b>		±1/4	<b>±1</b>		±1/2	<b>±1</b>	LSB
T <sub>A</sub> = T <sub>MIN</sub> to T <sub>MAX</sub>										LSB
Gain Error <sup>4</sup>		±0.1	<b>±0.2</b>		±0.1	<b>±0.2</b>		±0.1	<b>±0.2</b>	% of FSR <sup>5</sup>
Unipolar Offset Error <sup>4</sup>		±1	<b>±2</b>		±1	<b>±2</b>		±1	<b>±2</b>	LSB
Bipolar Zero Error <sup>4</sup>		±0.05	<b>±0.1</b>		±0.05	<b>±0.1</b>		±0.05	<b>±0.1</b>	% of FSR
<b>DRIFT</b>										
Gain T <sub>A</sub> = 25°C to T <sub>MIN</sub> or T <sub>MAX</sub>		±5	±30		±5	±15		±5	±30	ppm of FSR/°C
Unipolar Offset T <sub>A</sub> = 25°C to T <sub>MIN</sub> or T <sub>MAX</sub>		±1	±3		±1	±3		±1	±3	ppm of FSR/°C
Bipolar Zero T <sub>A</sub> = 25°C to T <sub>MIN</sub> or T <sub>MAX</sub>		±5	±10			±10		±5	±10	ppm of FSR/°C
<b>CONVERSION SPEED</b>										
Settling Time to ±0.01% of FSR for FSR change (2 kΩ  500 pF load)										
with 10 kΩ Feedback		3	4		3	4		3	4	μs
with 5 kΩ Feedback		2	3		2	3		2	3	μs
For LSB Change		1			1			1		μs
Slew Rate	10			10			10			V/μs
<b>ANALOG OUTPUT</b>										
Ranges <sup>6</sup>		±2.5, ±5, ±10, +5, +10			±2.5, ±5, ±10, +5, +10			±2.5, ±5, ±10, +5, +10		V
Output Current	±5			±5			±5			mA
Output Impedance (dc)		0.05			0.05			0.05		Ω
Short-Circuit Current			40			40			40	mA
<b>REFERENCE OUTPUT</b>										
External Current	<b>9.90</b>	10.00	<b>10.10</b>	<b>9.90</b>	10.00	<b>10.10</b>	<b>9.90</b>	10.00	<b>10.10</b>	V
	0.1	1.0		0.1	1.0		0.1	1.0		mA
<b>POWER SUPPLY SENSITIVITY</b>										
V <sub>CC</sub> = +11.4 to +16.5 V dc		5	<b>10</b>		5	<b>10</b>		5	<b>10</b>	ppm of FS/%
V <sub>EE</sub> = -11.4 to -16.5 V dc		5	<b>10</b>		5	<b>10</b>		5	<b>10</b>	ppm of FS/%
<b>POWER SUPPLY REQUIREMENTS</b>										
Rated Voltages		±12, ±15			±12, ±15			±12, ±15		V
Range <sup>6</sup>	<b>±11.4</b>		<b>±16.5</b>	<b>±11.4</b>		<b>±16.5</b>	<b>±11.4</b>		<b>±16.5</b>	V
Supply Current										
+11.4 to +16.5 V dc		9	<b>13</b>		9	<b>13</b>		9	<b>13</b>	mA
-11.4 to -16.5 V dc		18	<b>23</b>		18	<b>23</b>		18	<b>23</b>	mA
Total Power Consumption		400	600		400	600		400	600	mW
<b>TEMPERATURE RANGE</b>										
J/K	0		+70	0		+70				°C
A/B	-25		+85	-25		+85	-25		+85	°C
S	-55		+125	-55		+125				°C
Operating	-55		+125	-55		+125				°C
Storage (All Grades)	-65		+125	-65		+125	-65		+125	°C

## NOTES

<sup>1</sup>AD767 "S" specifications shown for information only. Consult Analog Devices Military Databook or contact factory for a controlled specification sheet.

<sup>2</sup>AD767A Chips specifications are tested at +25°C and, when in boldface, at +85°C. They are typical at -25°C.

<sup>3</sup>The digital input specifications are 100% tested at +25°C, and guaranteed but not tested over the full temperature range.

<sup>4</sup>Adjustable to zero.

<sup>5</sup>FSR means "Full-Scale Range" and is 20 V for ±10 V range and 10 V for the ±5 V range.

<sup>6</sup>A minimum power supply of ±12.5 V is required for a ±10 V full-scale output and ±11.4 V is required for all other voltage ranges.

Specifications subject to change without notice.

Specifications shown in boldface are tested on all production units at final electrical test (except per Notes 1 and 2). Results from those tests are used to calculate outgoing quality levels. All min and max specifications are guaranteed, although only those shown in boldface are tested on all production units.

**ABSOLUTE MAXIMUM RATINGS\***

- V<sub>CC</sub> to Power Ground . . . . . 0 V to +18 V
- V<sub>EE</sub> to Power Ground . . . . . 0 V to -18 V
- Digital Inputs (Pins 11, 13-24)  
to Power Ground . . . . . -1.0 V to +7.0 V
- Ref In to Reference Ground . . . . . ±12 V
- Bipolar Offset to Reference Ground . . . . . ±12 V
- 10 V Span R to Reference Ground . . . . . ±12 V
- 20 V Span R to Reference Ground . . . . . ±24 V

**TIMING SPECIFICATIONS**

(All Models, T<sub>A</sub> = 25°C, V<sub>CC</sub> = +12 V or +15 V, V<sub>EE</sub> = -12 V or -15 V)

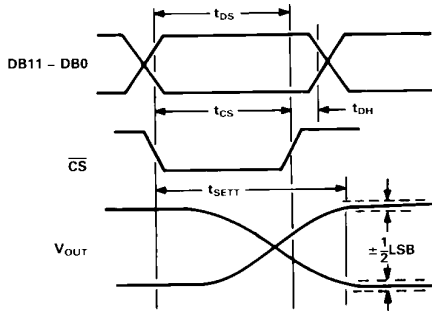

Ref Out, V<sub>OUT</sub> (Pins 6, 9) . . . Indefinite short to power ground  
Momentary Short to V<sub>CC</sub>  
Power Dissipation . . . . . 1000 mW

\*Stresses above those listed under "Absolute Maximum Ratings" may cause permanent damage to the device. This is a stress rating only and functional operation of the device at these or any other conditions above those indicated in the operational sections of this specification is not implied. Exposure to absolute maximum rating conditions for extended periods may affect device reliability.

Symbol	Parameter	Min	Typ	Max
t <sub>DS</sub>	Data Valid to End of $\overline{CS}$ (-25°C to +85°C) (-55°C to +125°C)	40	-	- ns
		60	-	- ns
		90	-	- ns
t <sub>DH</sub>	Data Hold Time (-25°C to +85°C) (-55°C to +125°C)	10	-	- ns
		10	-	- ns
		20	-	- ns
t <sub>CS</sub>	$\overline{CS}$ Pulse Width (-25°C to +85°C) (-55°C to +125°C)	40	-	- ns
		60	-	- ns
		90	-	- ns
t <sub>SETT</sub>	Output Voltage Settling Time*	-	2	4 μs

\*t<sub>SETT</sub> is measured referenced to the leading edge of t<sub>CS</sub>. If t<sub>CS</sub> > t<sub>DS</sub>, then t<sub>SETT</sub> is measured referenced to the beginning of Data Valid.

**PIN CONFIGURATION**

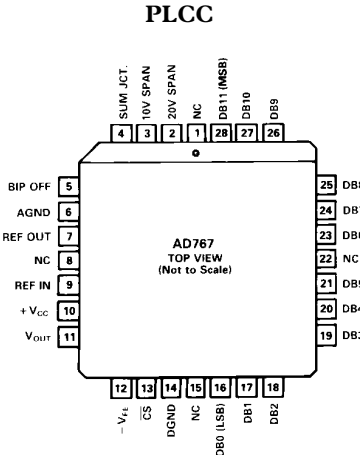
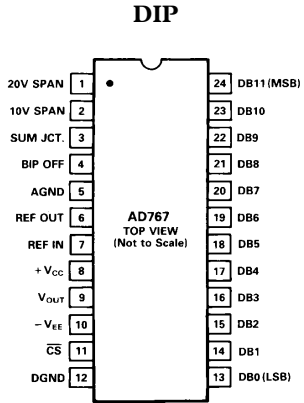

**ORDERING GUIDE**

Model <sup>1</sup>	Package	Temperature Range °C	Linearity Error Max T <sub>MIN</sub> -T <sub>MAX</sub>	Gain T.C. Max ppm/°C
AD767JN	Plastic DIP	0 to +70	±1 LSB	30
AD767JP	PLCC	0 to +70	±1 LSB	30
AD767KN	Plastic DIP	0 to +70	±1/2 LSB	15
AD767KP	PLCC	0 to +70	±1/2 LSB	15
AD767AD	Ceramic DIP	-25 to +85	±1 LSB	30
AD767BD	Ceramic DIP	-25 to +85	±1/2 LSB	15
AD767SD/ 883B	Ceramic DIP	-55 to +125	Note 2	Note 2
AD767A Chips	N/A	-25 to +85	±1 LSB	30

NOTES  
<sup>1</sup>D = Ceramic DIP; N = Plastic DIP; P = Plastic Leaded Chip Carrier.  
<sup>2</sup>For details on grade and package offerings screened in accordance with MIL-STD-883, refer to the Analog Devices Military Products Databook or current AD767/883B data sheet.

# AD767

## THE AD767 OFFERS TRUE 12-BIT PERFORMANCE OVER THE FULL TEMPERATURE RANGE

**LINEARITY ERROR:** Analog Devices defines linearity error as the maximum deviation of the actual, adjusted DAC output from the ideal analog output (a straight line drawn from 0 to F.S. - 1 LSB) for any bit combination. This is also referred to as relative accuracy. The AD767 is laser trimmed to typically maintain linearity errors at less than  $\pm 1/8$  LSB for the K and B versions and  $\pm 1/2$  LSB for the J, A and S versions. Linearity over temperature is also held to  $\pm 1/2$  LSB (K/B) or  $\pm 1$  LSB (J/A/S).

**MONOTONICITY:** A DAC is said to be monotonic if the output either increases or remains constant for increasing digital inputs such that the output will always be a nondecreasing function of input. All versions of the AD767 are monotonic over their full operating temperature range.

**DIFFERENTIAL NONLINEARITY:** Monotonic behavior requires that the differential linearity error be less than 1 LSB both at  $+25^\circ\text{C}$  as well as over the temperature range of interest. Differential nonlinearity is the measure of the variation in analog value, normalized to full scale, associated with a 1 LSB change in digital input code. For example, for a 10 volt full-scale output, a change of 1 LSB in digital input code should result in a 2.44 mV change in the analog output ( $1 \text{ LSB} = 10 \text{ V} \times 1/4096 = 2.44 \text{ mV}$ ). If in actual use, however, a 1 LSB change in the input code results in a change of only 0.61 mV ( $1/4 \text{ LSB}$ ) in analog output, the differential nonlinearity error would be  $-1.83 \text{ mV}$ , or  $-3/4 \text{ LSB}$ .

**GAIN ERROR:** DAC gain error is a measure of the difference between an ideal DAC and the actual device's output span. All grades of the AD767 have a maximum gain error of 0.2% FS. However, if this is not sufficient, the error can easily be adjusted to zero (see Figures 2 and 3).

**UNIPOLAR OFFSET ERROR:** Unipolar offset error is a combination of the offset errors of the voltage-mode DAC and the output amplifier and is measured when the AD767 is configured for unipolar outputs. It is present for all codes and is measured with all "0s" in the DAC latches. This is easily adjustable to zero when required.

**BIPOLAR ZERO ERROR:** Bipolar zero errors result from errors produced by the DAC and output amplifier when the AD767 is configured for bipolar output. Again, as with unipolar offset and gain errors, this is easily adjusted to zero when required.

## ANALOG CIRCUIT CONNECTIONS

Internal scaling resistors provided in the AD767 may be connected to produce bipolar output voltage ranges of  $\pm 10$ ,  $\pm 5$  or  $\pm 2.5 \text{ V}$  or unipolar output voltage ranges of 0 to  $+5 \text{ V}$  or 0 to  $+10 \text{ V}$ .

Gain and offset drift are minimized in the AD767 because of the thermal tracking of the scaling resistors with other device components. Connections for various output voltage ranges are shown in Table I.

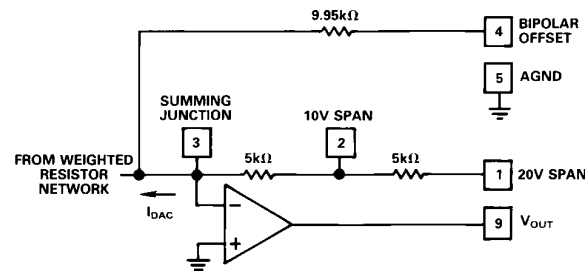

Figure 1. Output Amplifier Voltage Range Scaling Circuit

## UNIPOLAR CONFIGURATION (Figure 2)

This configuration will provide a unipolar 0 to  $+10 \text{ volt}$  output range. In this mode, the bipolar offset terminal, Pin 4, should be grounded if not used for trimming.

### STEP I ... ZERO ADJUST

Turn all bits OFF and adjust zero trimmer R1, until the output reads 0.000 volts ( $1 \text{ LSB} = 2.44 \text{ mV}$ ). In most cases this trim is not needed, and Pin 4 should be connected to Pin 5.

### STEP II ... GAIN ADJUST

Turn all bits ON and adjust  $100 \Omega$  gain trimmer R2 until the output is 9.9976 volts. (Full scale is adjusted to 1 LSB less than nominal full scale of 10.000 volts.)

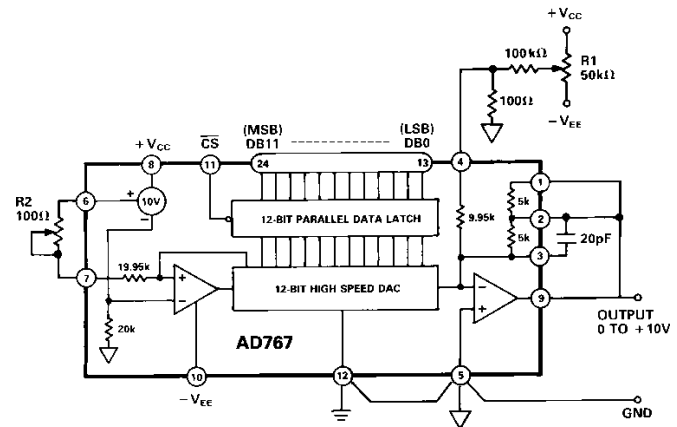

Figure 2. 0 to  $+10 \text{ V}$  Unipolar Voltage Output

Table I. Output Voltage Range Connections

Output Range	Digital Input Codes	Connect Pin 9 to	Connect Pin 1 to	Connect Pin 2 to	Connect Pin 4 to
$\pm 10 \text{ V}$	Offset Binary	1	9	NC	6 (through $50 \Omega$ fixed or $100 \Omega$ trim resistor)
$\pm 5 \text{ V}$	Offset Binary	1 and 2	2 and 9	1 and 9	6 (through $50 \Omega$ fixed or $100 \Omega$ trim resistor)
$\pm 2.5 \text{ V}$	Offset Binary	2	3	9	6 (through $50 \Omega$ fixed or $100 \Omega$ trim resistor)
0 to $+10 \text{ V}$	Straight Binary	1 and 2	2 and 9	1 and 9	5 (or optional trim – See Figure 2)
0 to $+5 \text{ V}$	Straight Binary	2	3	9	5 (or optional trim – See Figure 2)

**BIPOLAR CONFIGURATION (Figure 3)**

This configuration will provide a bipolar output voltage from  $-5.000$  to  $+4.9976$  volts, with positive full scale occurring with all bits ON (all 1s).

**STEP I ... OFFSET ADJUST**

Turn OFF all bits. Adjust  $100\ \Omega$  trimmer R1 to give  $-5.000$  volts output.

**STEP II ... GAIN ADJUST**

Turn ON all bits. Adjust  $100\ \Omega$  gain trimmer R2 to give a reading of  $+4.9976$  volts.

**STEP III ... BIPOLAR ZERO ADJUST (Optional)**

In applications where an accurate zero output is required, set the MSB ON, all other bits OFF, and readjust R1 for zero volts output.

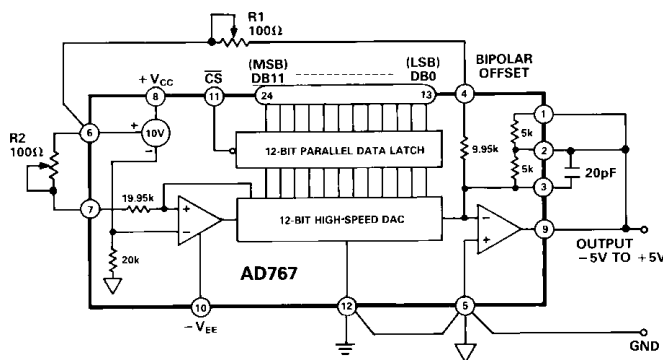

Figure 3.  $\pm 5$  V Bipolar Voltage Output

**INTERNAL/EXTERNAL REFERENCE USE**

The AD767 has an internal low-noise buried Zener diode reference which is trimmed for absolute accuracy and temperature coefficient. This reference is buffered and optimized for use in a high-speed DAC and will give long-term stability equal or superior to the best discrete Zener reference diodes. The performance of the AD767 is specified with the internal reference driving the DAC since all trimming and testing (especially for full-scale error and bipolar offset) is done in this configuration.

The internal reference has sufficient buffering to drive external circuitry in addition to the reference currents required for the DAC (typically  $0.5\ \text{mA}$  to Ref In and  $1.0\ \text{mA}$  to Bipolar Offset). A minimum of  $0.1\ \text{mA}$  is available for driving external loads.

The AD767 reference output should be buffered with an external op amp if it is required to supply more than  $0.1\ \text{mA}$  output current. The reference is typically trimmed to  $\pm 0.2\%$ , then tested and guaranteed to  $\pm 1.0\%$  max error. The temperature coefficient is comparable to that of the full-scale TC for a particular grade.

If an external reference is used ( $10.000\ \text{V}$ , for example), additional trim range must be provided, since the internal reference has a tolerance of  $\pm 1\%$ , and the AD767 full-scale and bipolar offset are both trimmed with the internal reference. The gain and offset trim resistors give about  $\pm 0.25\%$  adjustment range, which is sufficient for the AD767 when used with the internal reference.

It is also possible to use external references other than 10 volts. The recommended range of reference voltage is from  $+8$  to  $+10.5$  volts, which allows both  $8.192\ \text{V}$  and  $10.24\ \text{V}$  ranges to be used. The AD767 is optimized for fixed-reference applications. If the reference voltage is expected to vary over a wide range in a particular application, a CMOS multiplying DAC is a better choice.

Reduced values of reference voltage will also permit the  $\pm 12\ \text{V}$   $\pm 5\%$  power supply requirement to be relaxed to  $\pm 12\ \text{V}$   $\pm 10\%$ .

It is not recommended that the AD767 be used with external feedback resistors to modify the scale factor. The internal resistors are trimmed to ratio-match and temperature-track the other resistors on the chip, even though their absolute tolerances are  $\pm 20\%$ , and absolute temperature coefficients are approximately  $-50\ \text{ppm}/^\circ\text{C}$ . If external resistors are used, a wide trim range ( $\pm 20\%$ ) will be needed and temperature drift will be increased to reflect the mismatch between the temperature coefficients of the internal and external resistors.

Small resistors may be added to the feedback resistors in order to accomplish small modifications in the scaling. For example, if a  $10.24\ \text{V}$  full scale is desired, a  $140\ \Omega$   $1\%$  low-TC metal-film resistor can be added in series with the internal (nominal)  $5\ \text{k}$  feedback resistor, and the gain trim potentiometer (between Pins 6 and 7) should be increased to  $200\ \Omega$ . In the bipolar mode, increase the value of the bipolar offset trim potentiometer also to  $200\ \Omega$ .

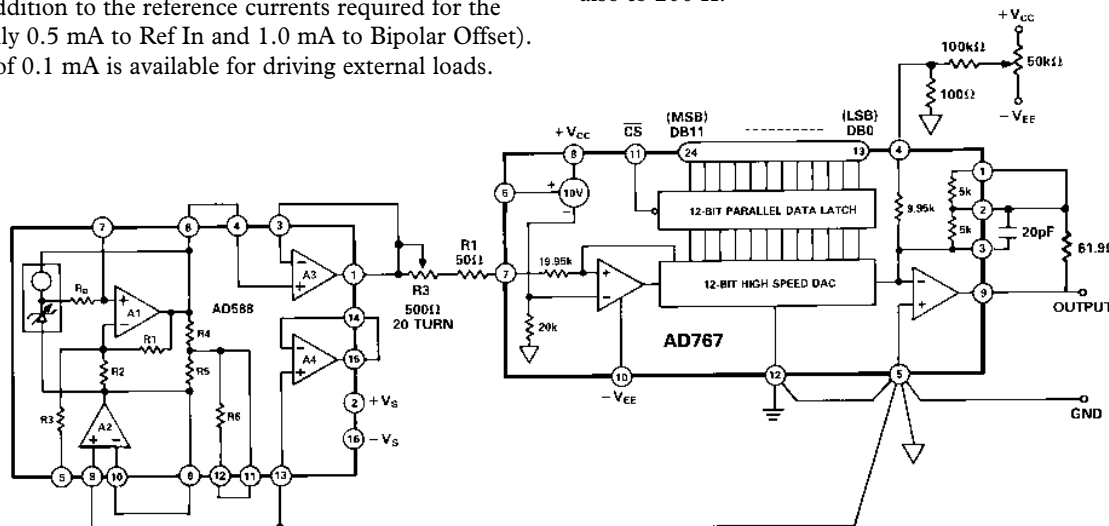

Figure 4. Using the AD767 with the AD588 High Precision Reference

# AD767

## USING THE AD767 WITH THE AD588 HIGH PRECISION VOLTAGE REFERENCE

The AD767 is specified for gain drift from 15 ppm/°C to 30 ppm/°C (depending on grade) using its internal 10 volt reference. Since the internal reference contributes the majority of this drift, an external high-precision voltage reference will greatly improve performance over temperature. As shown in Figure 4, the 10 volt output from the AD588 is used as the reference. With a 1.5 ppm/°C output voltage drift the AD588 contributes less than 1/2 LSB gain drift when used with the AD767 over the industrial temperature range. Using this combination may result in apparent increases in full-scale error due to the differences between the internal reference by which the device is laser trimmed and the external reference with which the device is actually applied. The AD767 internal reference is specified to be 10 volts  $\pm$  100 mV whereas the AD588 is specified as 10 volts  $\pm$  1 mV. This may result in up to 101 mV of apparent full-scale error beyond the  $\pm$ 25 mV specified AD767 gain error. The 500  $\Omega$  potentiometer in series with the reference input allows adequate trim range to null this error.

## GROUNDING RULES

The AD767 brings out separate analog and power grounds to allow optimum connections for low noise and high-speed performance. These grounds should be tied together at one point, usually the device power ground. The separate ground returns are provided to minimize current flow in low-level signal paths.

The analog ground at Pin 5 is the ground point for the output amplifier and is thus the “high quality” ground for the AD767; it should be connected directly to the analog reference point of the system. The power ground at Pin 12 can be connected to the most convenient ground point; analog power return is preferred. If power ground contains high frequency noise beyond 200 mV, this noise may feed through the converter, thus some caution will be required in applying these grounds.

It is also important to apply decoupling capacitors properly on the power supplies for the AD767. The correct method for decoupling is to connect a capacitor from each power supply pin of the AD767 to the analog ground pin of the AD767. Any load driven by the output amplifier should also be referred to the analog ground pin.

## OPTIMIZING SETTling TIME

The dynamic performance of the AD767's output amplifier can be optimized by adding a small (20 pF) capacitor across the feedback resistor. Figure 5 shows the improvement in both large-signal and small-signal settling for the 10 V range. In Figure 5a, the top trace shows the data inputs (DB11–DB0 tied together), the second trace shows the CS pulse, and the lower two traces show the analog outputs for  $C_F = 0$  and 20 pF respectively.

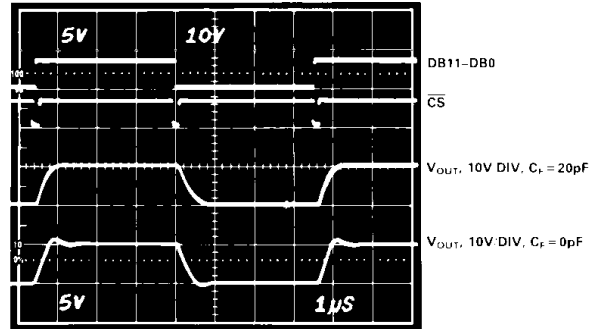

Figure 5a. Large Scale Settling

Figures 5b and 5c show the settling time for the transition from all bits on to all bits off. Note that the settling time to  $\pm$ 1/2 LSB for the 10 V step is improved from 2.4 microseconds to 1.6 microseconds by the addition of the 20 pF capacitor.

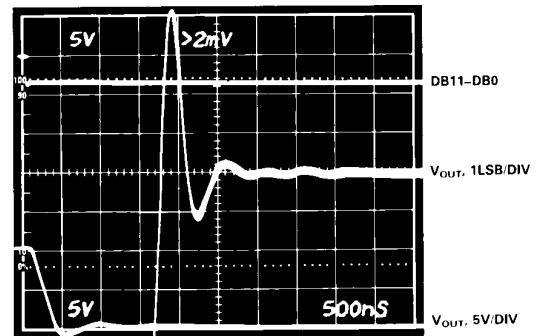

Figure 5b. Fine-Scale Settling,  $C_F = 0$  pF

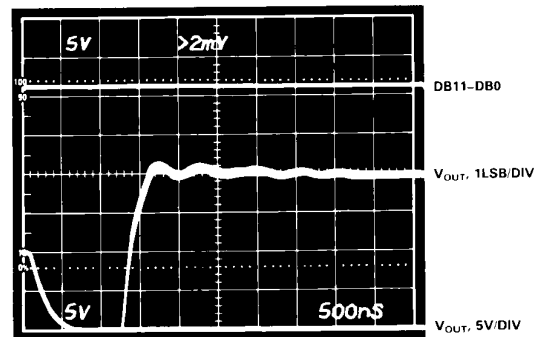

Figure 5c. Fine-Scale Settling,  $C_F = 20$  pF

Figures 5d and 5e show the settling time for the transition from all bits off to all bits on. The improvement in settling time gained by adding  $C_C = 20$  pF is similar.

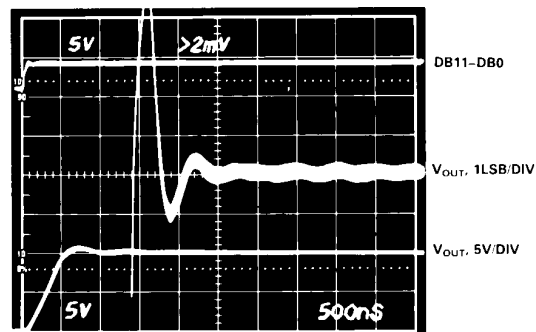

Figure 5d. Fine-Scale Settling,  $C_F = 0$  pF

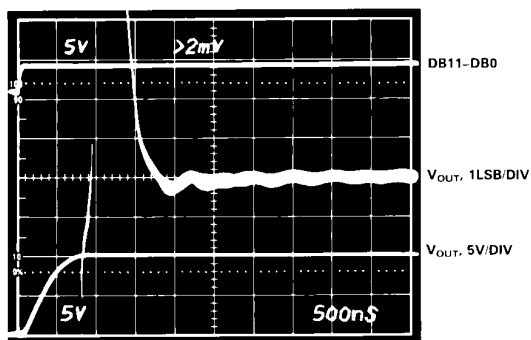

Figure 5e. Fine-Scale Settling,  $C_F = 20 \text{ pF}$

### DIGITAL INPUT CONSIDERATIONS

The threshold of the digital input circuitry is set at 1.4 volts and does not change with supply voltage. Thus the AD767 digital interface may be driven with any of the popular types of 5 volt logic.

A good engineering practice is to connect unused inputs to power ground to improve noise immunity. Unconnected data and control inputs will float to logic 0 if left open.

The low digital input current of the AD767 eliminates the need for buffer/drivers required by many monolithic converters using bipolar technology. A single low-power Schottky gate, for example, will drive several AD767s when connected to a common bus.

### INPUT CODING

The AD767 uses positive-true binary input coding. Logic "1" is represented by an input voltage greater than 2.0 V, and logic "0" is defined as an input voltage less than 0.8 V.

Unipolar coding is straight binary, where all zeroes (000<sub>H</sub>) on the data inputs yields a zero analog output and all ones (FFF<sub>H</sub>) yields an analog output 1 LSB below full scale.

Bipolar coding is offset binary, where an input code of 000<sub>H</sub> yields a minus full-scale output, an input of FFF<sub>H</sub> yields an output 1 LSB below positive full scale, and zero occurs for an input code with only the MSB on (800<sub>H</sub>).

The AD767 can be used with twos complement input coding if an inverter is used on the MSB (DB11).

### MICROPROCESSOR INTERFACE

The AD767, with its 40 ns minimum  $\overline{\text{CS}}$  pulse width, may be easily interfaced to any of today's high-speed microprocessors. The 12-bit single buffered input register will accept 12-bit parallel data from processors such as the 68000, 8086, TMS320 series, and the Analog Devices ADSP-2100. Several illustrative examples follow.

#### 68000 – AD767 INTERFACE

Figure 6 illustrates the AD767 interface to a 68000 microprocessor. An active low decoded address is OR'ed with the processor's  $\overline{\text{R/W}}$  signal to provide  $\overline{\text{CS}}$  and latch data into the AD767. Later in the bus cycle the processor issues the upper ( $\overline{\text{UDS}}$ ) and lower ( $\overline{\text{LDS}}$ ) data strobes which are gated with the decoded address to provide  $\overline{\text{DTACK}}$  and terminate the bus cycle. As shown, this interface will support a 12.5 MHz 68000 system.

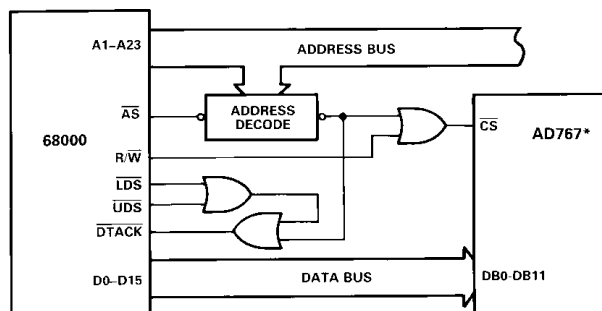

\*LINEAR CIRCUITRY OMITTED FOR CLARITY

Figure 6. 68000 – AD767 Interface

#### 8086 – AD767 INTERFACE

Interfacing the AD767 to the 8086 16-bit microprocessor requires a minimal amount of external components. A 10 MHz 8086, for example, generates a 165 ns low write pulse which may be gated with a decoded address to provide  $\overline{\text{CS}}$  for the AD767. As  $\overline{\text{WR}}$  returns high valid data is latched into the DAC. See Figure 7.

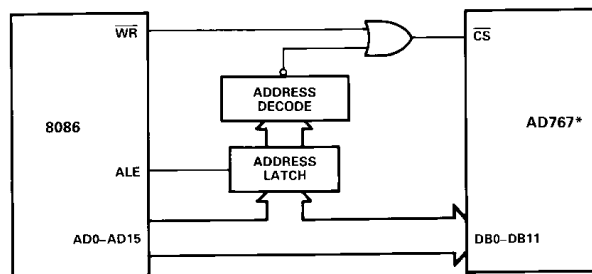

\*LINEAR CIRCUITRY OMITTED FOR CLARITY

Figure 7. 8086 – AD767 Interface

#### TMS32010 – AD767 INTERFACE

The high-speed digital interface of the AD767 facilitates its use with the TMS32010 microprocessor at speeds up to 20 MHz. In the three multiplexed LSBs of the address bus, PA2 – PA0 are decoded as a port address and OR'ed with the low write enable to generate  $\overline{\text{CS}}$  for the DAC. A simple OUT xx,y instruction will output the data word stored in memory location xx to any one of eight port locations y.

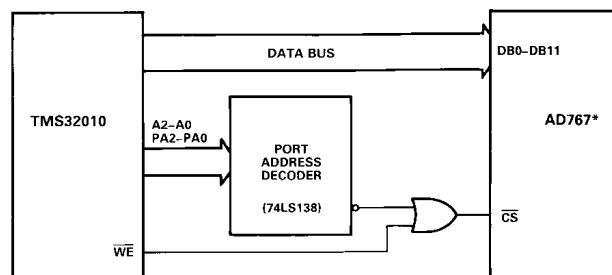

Figure 8. TMS32010 – AD767 Interface

#### TMS32020 – AD767 INTERFACE

Interfacing the AD767 to the TMS32020 microprocessor is easily achieved by using the TMS32020 I/O port capability. The  $\overline{\text{IS}}$  signal distinguishes the I/O address space from the local program/data memory space and is used to enable a 74LS138 decoder. The decoded port address is then gated with the  $\overline{\text{R/W}}$  and  $\overline{\text{STRB}}$  signals to provide the AD767  $\overline{\text{CS}}$ .

# AD767

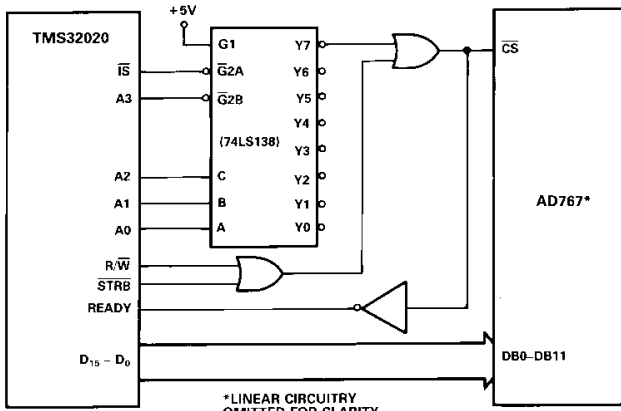

Figure 9. TMS32020 - AD767 Interface

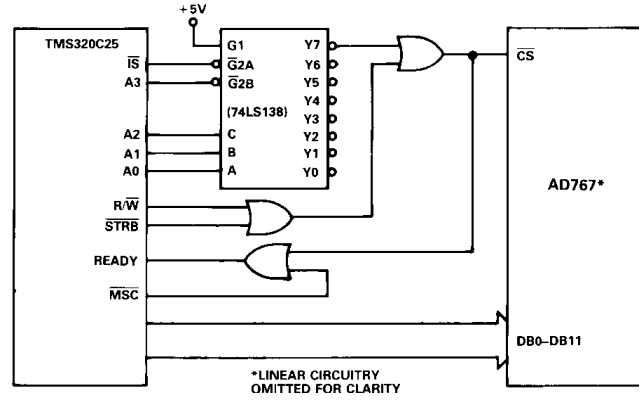
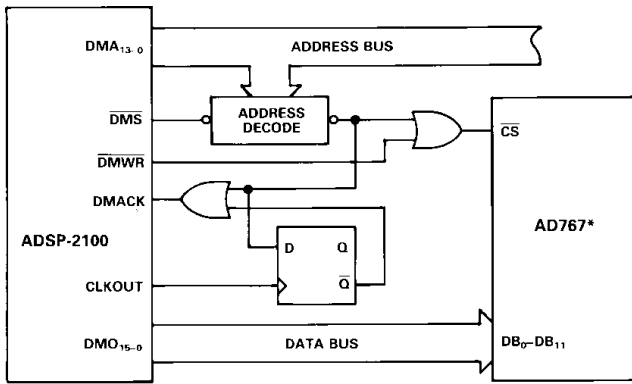

Figure 11. TMS320C25 - AD767 Interface

## ADSP-2100 - AD767 INTERFACE

The ADSP-2100 single chip DSP processor may be interfaced to the AD767 as shown in Figure 10. With a clock frequency of 32 MHz, and instruction execution in a single 125 ns cycle, the processor will support the AD767 interface with a single wait state.



\*LINEAR CIRCUITRY OMITTED FOR CLARITY

Figure 10. ADSP-2100 - AD767 Interface

At the beginning of the data memory access cycle the processor provides a 14-bit address on the DMA bus. The  $\overline{\text{DMS}}$  signal is then asserted enabling a LOW address decode. Valid data is now placed on the data bus and  $\overline{\text{DMWR}}$  is issued.  $\overline{\text{DMWR}}$  is OR'ed with the LOW address decode to generate the AD767  $\overline{\text{CS}}$ .

The LOW decoded address is also gated with the  $\overline{\text{Q}}$  output of a D flip-flop to hold DMACK (Data Memory Acknowledge) LOW. This forces the processor into a wait state and extends the AD767  $\overline{\text{CS}}$  by 1 clock cycle. The rising edge of CLKOUT latches  $\overline{\text{Q}}$  HIGH bringing DMACK HIGH. The cycle is now complete.

## TMS320C25 - AD767 INTERFACE

Figure 11 illustrates the AD767 interface to a TMS320C25 digital signal processor. Due to the high-speed capability of the processor (40 MHz), a single wait state is required and is easily generated using MSC. A 20 MHz TMS320C25 however, does not require wait states and should be interfaced using the circuit shown in Figure 9.

## OUTLINE DIMENSIONS

Dimensions shown in inches and (mm).

### 24-Pin Ceramic (Suffix D)

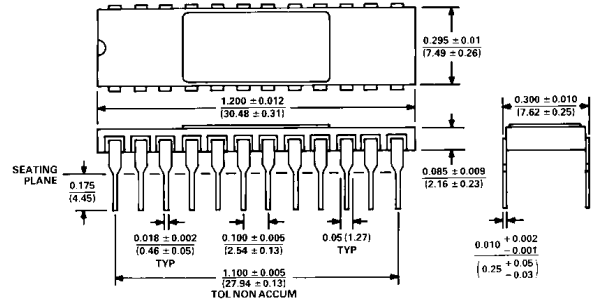

- NOTES  
 1. LEAD NO. 1 IDENTIFIED BY DOT OR NOTCH.  
 2. CERAMIC DIP LEADS WILL BE EITHER GOLD OR TIN PLATED IN ACCORDANCE WITH MIL-M-385 TO REQUIREMENTS.  
 3. METAL LID IS CONNECTED TO  $-V_{EE}$ .

### 24-Pin Plastic (Suffix N)

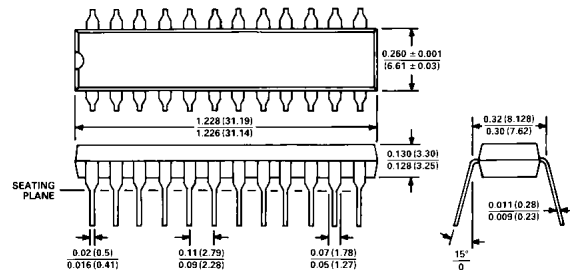

### 28-Pin PLCC (Suffix P)

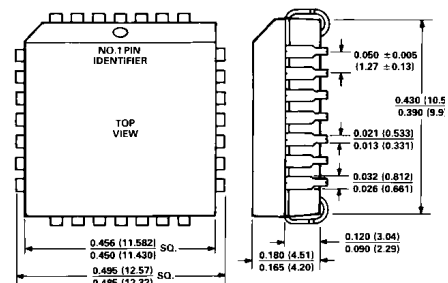

- NOTES  
 1. LEAD NO. 1 IDENTIFIED BY DOT OR NOTCH.  
 2. PLASTIC LEADS WILL BE EITHER SOLDER DIPPED OR TIN LEAD PLATED IN ACCORDANCE WITH MIL-M-38510 REQUIREMENTS.